

We support PV systems



SolidRail System

Roof hooks plain tiles

ASSEMBLY MANUAL

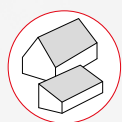
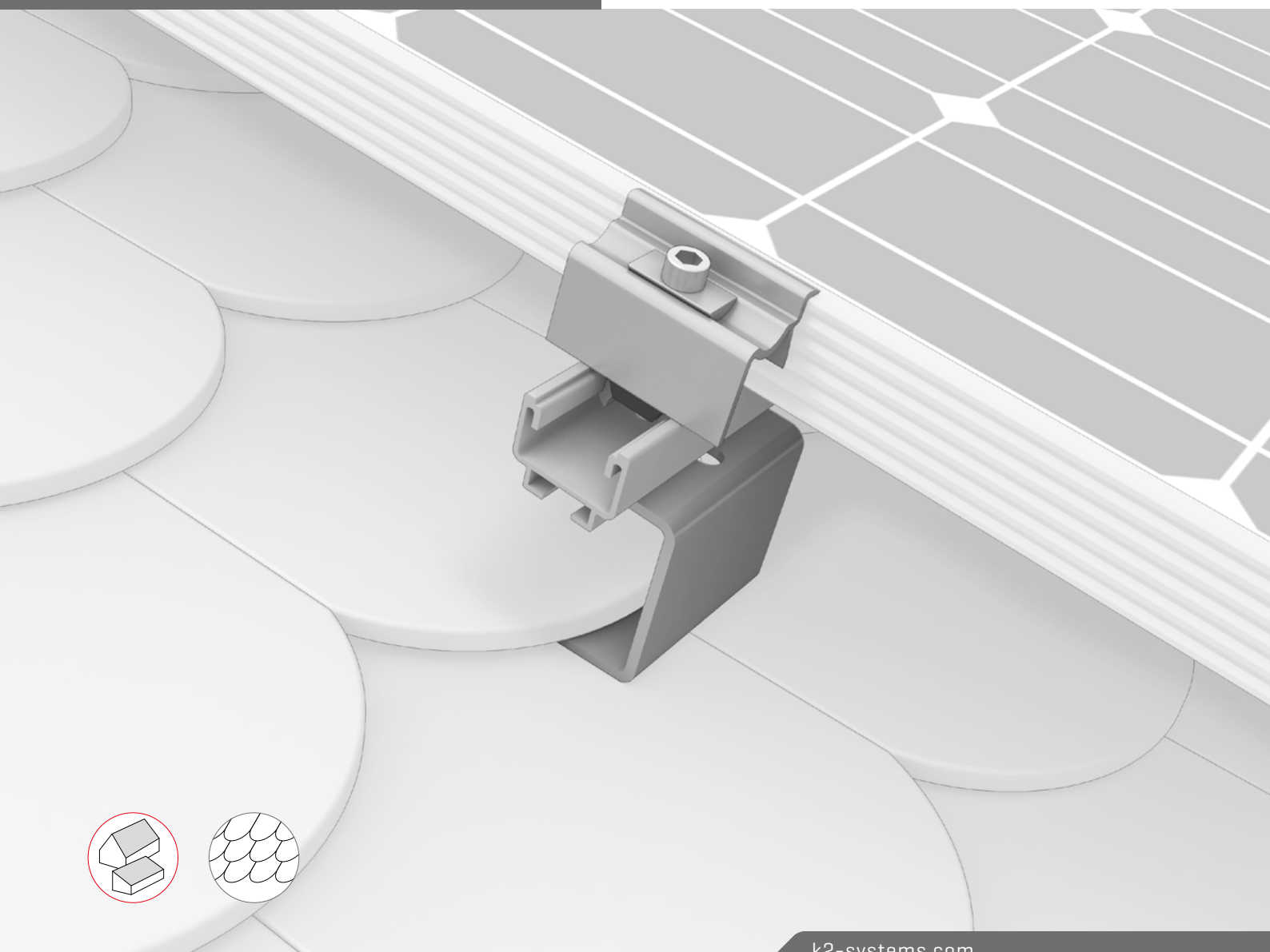

Content

| | |
|---------------------------------------|----|
| / Tools overview | 3 |
| / General safety information | 4 |
| / The following guidelines apply | 5 |
| · Roof requirements | 5 |
| · Important mounting instructions | 5 |
| / Components | 6 |
| · Portrait assembly | 6 |
| · Additional items landscape assembly | 8 |
| / Assembly | 9 |
| · Portrait | 9 |
| · Landscape | 12 |
| · Cable Management | 14 |
| / Notes | 15 |

Quality tested – several certifications

K2 Systems stands for secure connections, highest quality and precision. Our customers and business partners have known that for a long time. Independent institutes have tested, confirmed and certified our capabilities and components.

Please find our quality and product certificates under:
www.k2-systems.com/en/technical-information

Tools overview

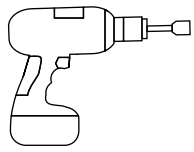

6 mm



15 mm



25/40

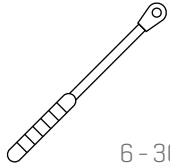

6 - 30 Nm
[4.5 - 22.2 lb-ft]



6 mm



15 mm

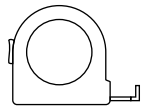

≥ 3.0 m



≥ 6.0 m

Digital Toolbox



Do you already know our digital services? Use our K2 DocuApp now and record the first important data directly at the customer or project site. Simply transfer the data to our online planning software K2 Base. Here you can plan your project easily, safely and quickly. You receive a detailed project report with assembly plan and static report. The K2+ interface enables seamless project data transfer to the planning tools of other manufacturers. With the K2 DocuApp, project documentation is done quickly and easily - without annoying paperwork.

Get started and register now:

base.k2-systems.com →

docuapp.k2-systems.com →

General safety information

Please note that our general mounting instructions must be followed at all times and can be viewed online at k2-systems.com/en/technical-information

- The equipment may only be installed and operated by qualified and adequately trained installers.
- Prior to installation, ensure that the product complies with on-site static loading requirements. For roof-mounted systems, the roof load-bearing capacity must always be checked.
- National and local building regulations and environmental requirements must be adhered to.
- Compliance with health and safety regulations, accident prevention guidelines and applicable standards is required.
 - Protective equipment such as safety helmet, boots and gloves must be worn.
 - Roofing works must be in accordance with roofing regulations utilising fall protection safeguards when eaves height exceeds 3 m.
 - At least two people must be present for the duration of the installation work in order to provide rapid assistance in the event of an emergency.
- K2 mounting systems are continuously developed and improved and the installation process may thereby change at any time. Prior to installation consult our website at www.k2-systems.com/en/technical-information for up-to-date instructions. We can send you the latest version on request.
- The assembly instructions of the module manufacturer must be adhered to.
- Equipotential bonding/grounding/earthing between individual parts is to be performed according to country specific standards, as well as national laws and regulations.
- At least one copy of the assembly instructions should be available on site throughout the duration of the installation.
- Failure to adhere to our general safety and assembly instructions and not using all system components, K2 is not liable for any resulting defects or damages. We do not accept liability for any damage resulting in the use of competitor's parts. Warranty is excluded in such cases.
- German law shall apply excluding the UN Convention on CISG. Place of venue is Stuttgart. Our General Terms of Business apply.
- If all safety instructions are adhered to and the system is correctly installed, there is a product warranty entitlement of 12 years! We strongly recommend reviewing our terms of guarantee, which can be viewed at www.k2-systems.com/en/technical-information We will also send this information on request.
- Dismantling of the system is performed in reverse order to the assembly.
- K2 stainless steel components are available in different corrosion resistance classes. Each structure or component must be carefully checked for possible corrosion exposure.

The following guidelines apply

The plain tile roof hook system can be used without further testing by K2 Systems in the following standard conditions. To calculate maximum distances between supports we recommend using our calculation tool K2 Base. The system is also suitable for higher requirements. However, if a value exceeds the standard conditions, please contact K2 Systems.



Roof requirements

- The sufficient holding force at the support or sub-structure must be ensured on site.
- Roof pitch: 18 - 75°



Important mounting instructions

- On-site general standards and regulations for lightning protection must be observed and consultation with a specialist to create a lightning protection concept is recommended (use lightning protection clamp if necessary).
- We recommend a thermal separation after maximum of 17.6 m.
- A minimum mounting distance of 50 mm from the end of the rail / rail joint to the module frame.
- Tightening torque for all module clamps 16 Nm
- For manufacturer information regarding clamps see the manufacturing module data sheet.
- To avoid tiles breaking under high snow loads, arrange for supporting the bracket with a suitable metal support plate.
- Do not step on roof hooks or rails, aren't climbing assists.
- Sizing and positioning of the wood screws are subject to the relevant regulations.
- Dimensioning and positioning of the wood screws subject to the European Technical approvals (ETA) of the screw manufacturers.
- Special requirements apply with on-rafter insulation or counter battening: Special fit-for-purpose spacer screws have to be used.

Components

Portrait assembly

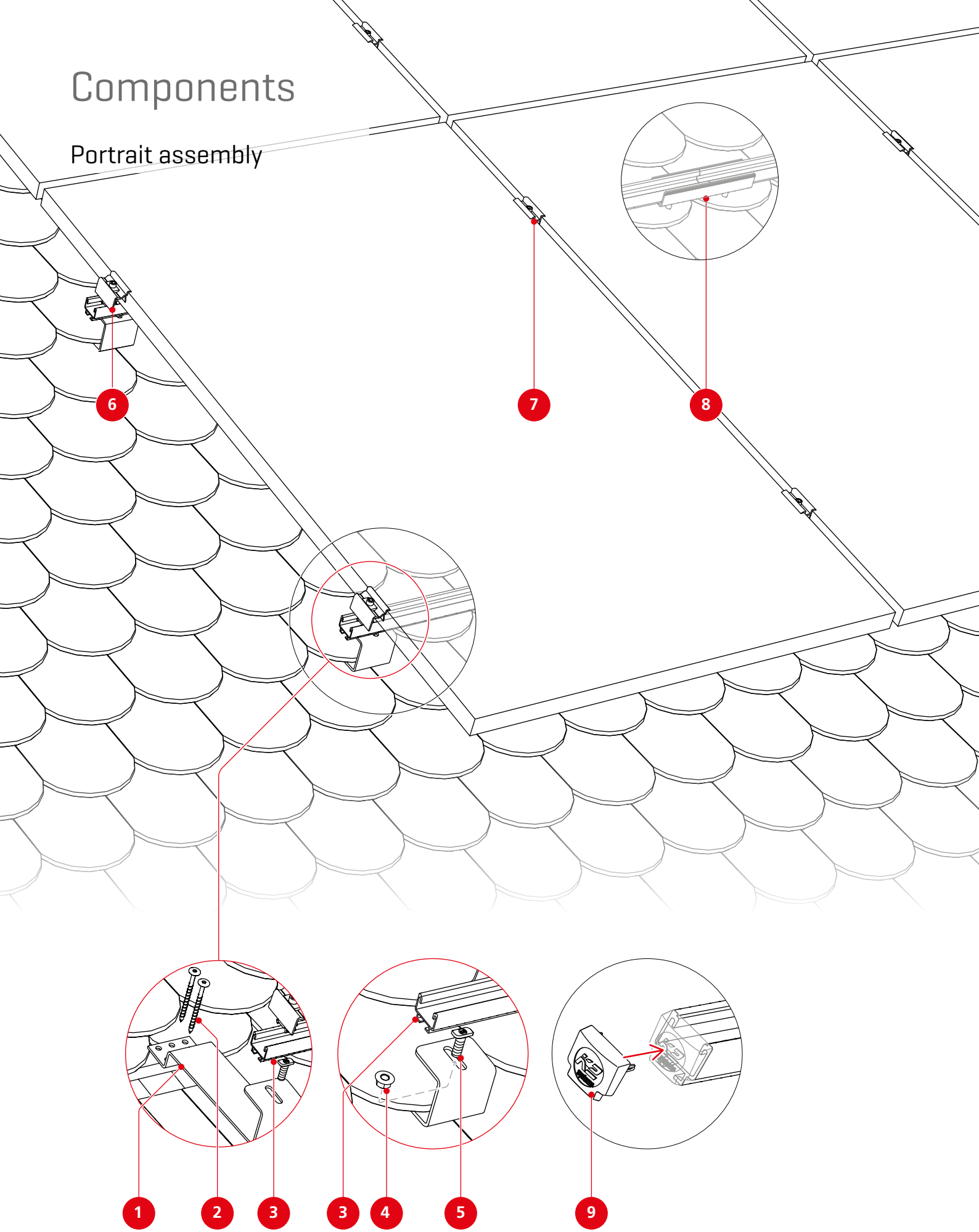

1 2003073
SolidHook for plain tiles

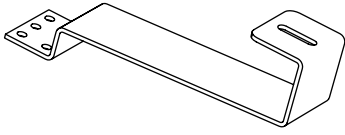

2 Item number project specific!
Heco Topix wood screw, Flange Head, T-Drive

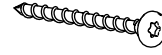

3 Item number project specific!
Mounting rail SolidRail

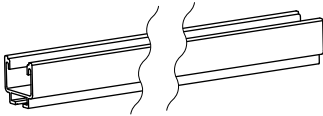

4 1000042
Hexagon flange nut with serration, M10

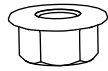

5 Item number project specific!
T-bolt M10×20 / M10×30



6 2004147 / 2004149
K2 Clamp EC 25 - 37



2002514 / 2002589
OneEnd



Item number project specific!
Module end clamp standard



7 2004146 / 2004148
K2 Clamp MC 25 - 40



2003071 / 2003072
OneMid



Item number project specific!
Module middle clamp XS



8 Item number project specific!
SolidRail Connector Set

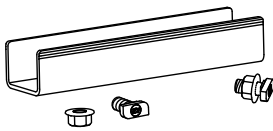

9 Item number project specific!
SolidRail EndCap

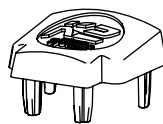

Optional

2002870
Cable Manager

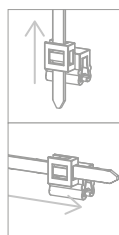
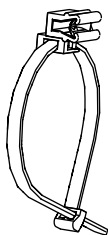

Components

Additional items landscape assembly

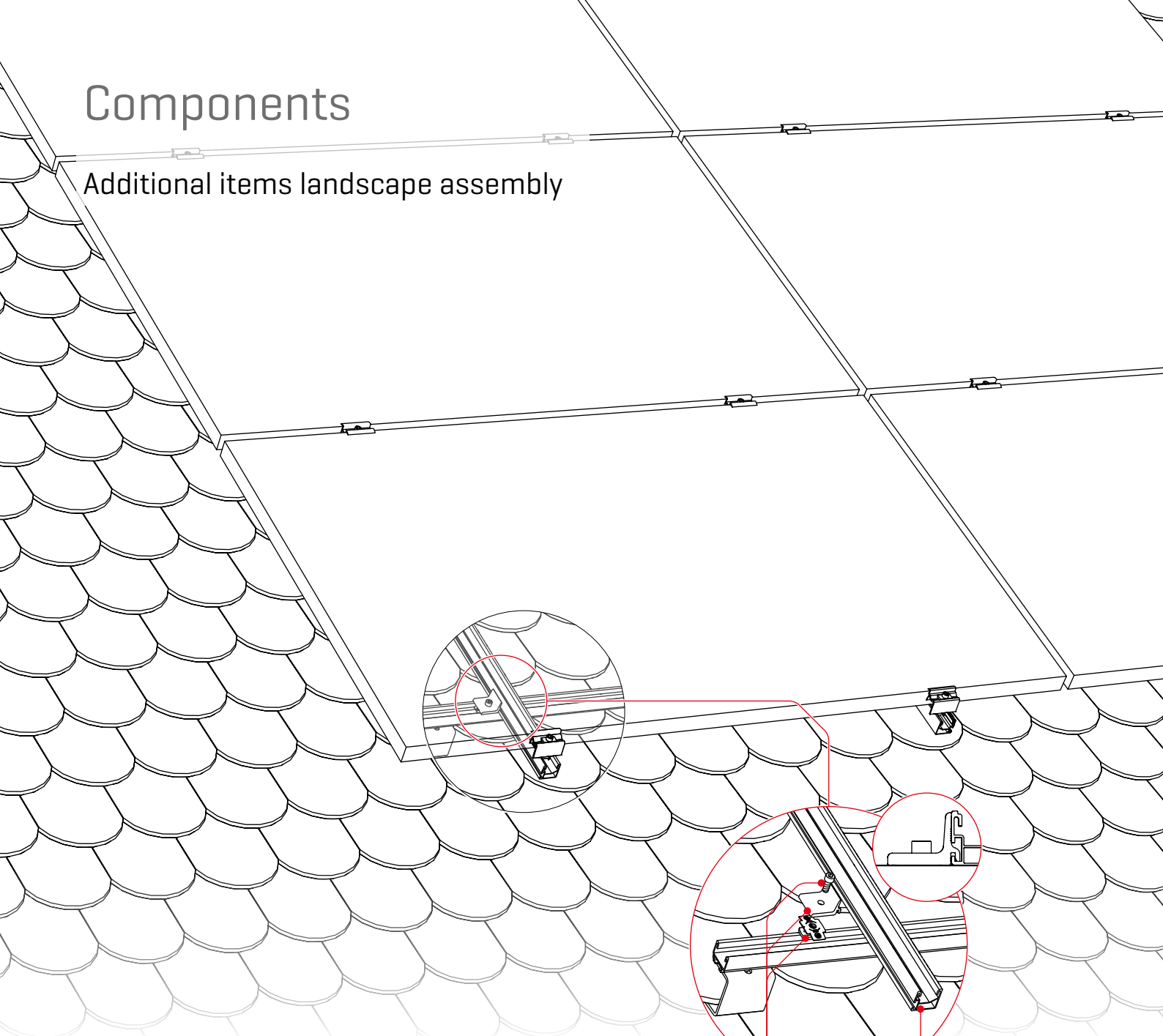

1 2003145
Climber 36/50 Set

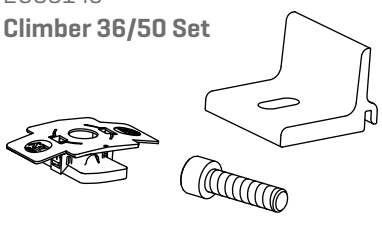

1

2

2 Item number project
specific!
SingleRail 36/50

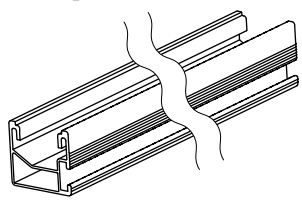

Optional:
2001976 / 2002404
SingleRail 36/50 Connector Set

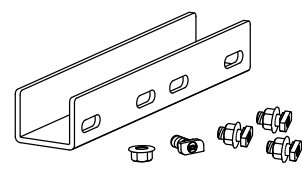

Assembly



Portrait

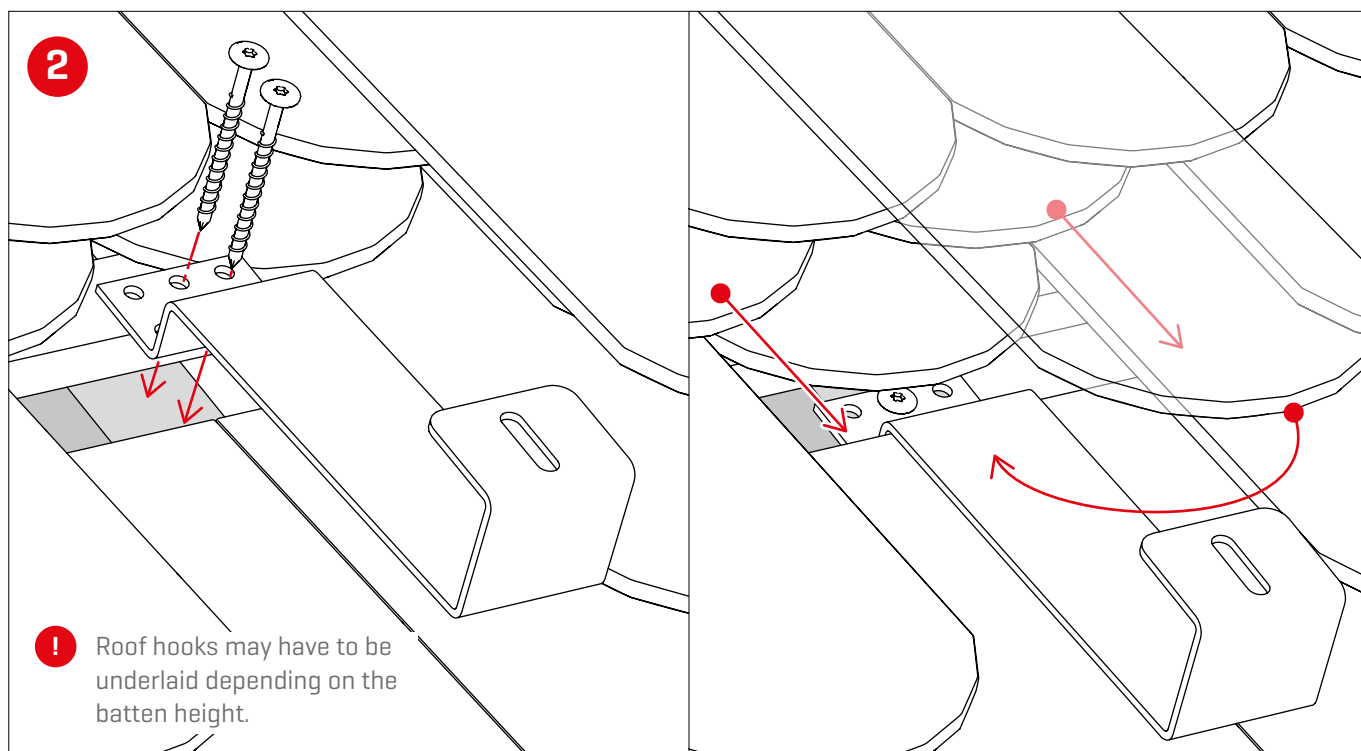
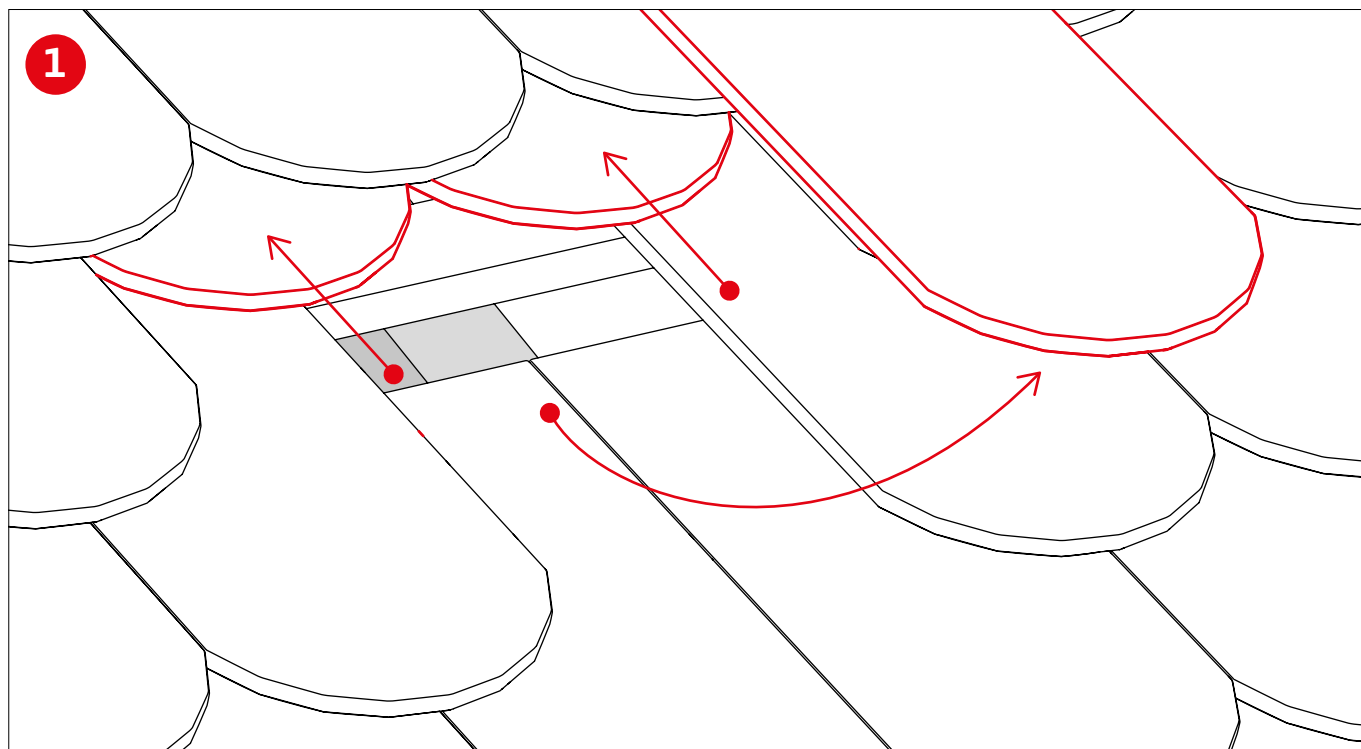

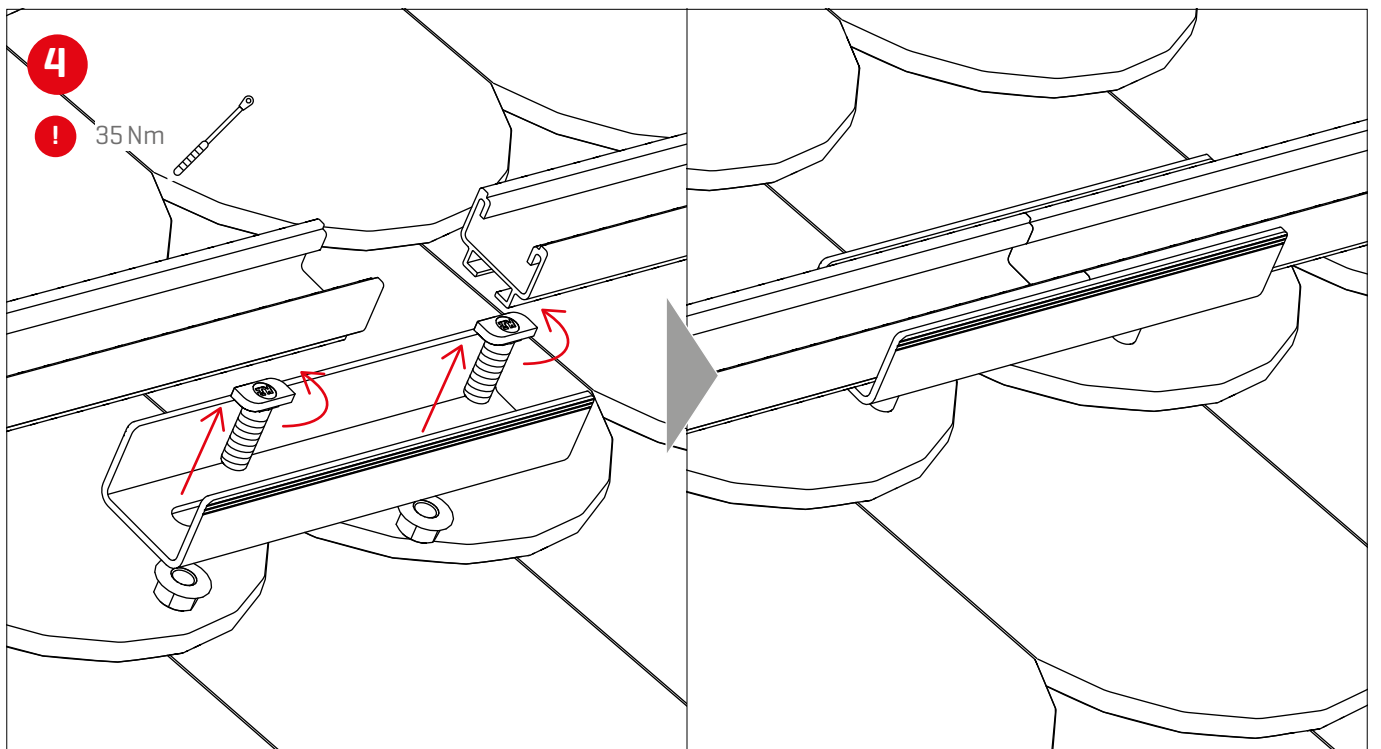
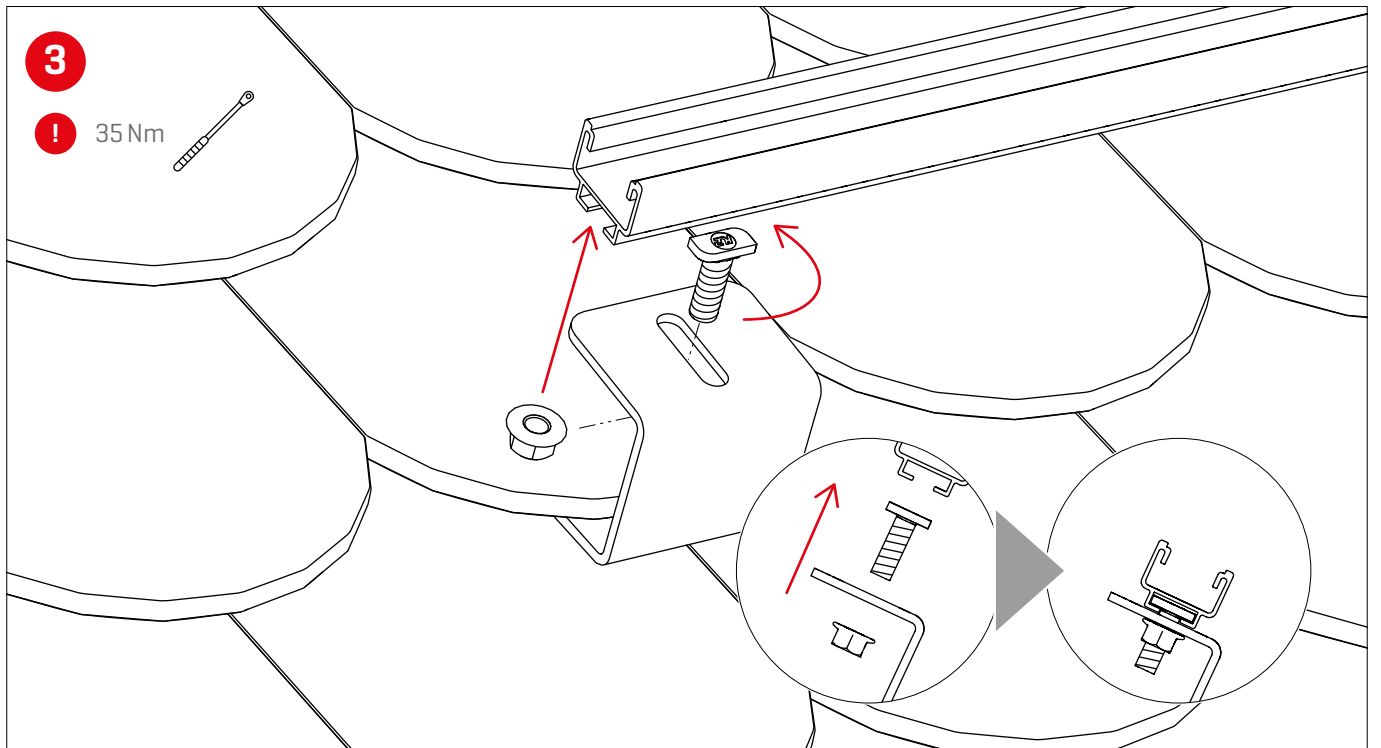

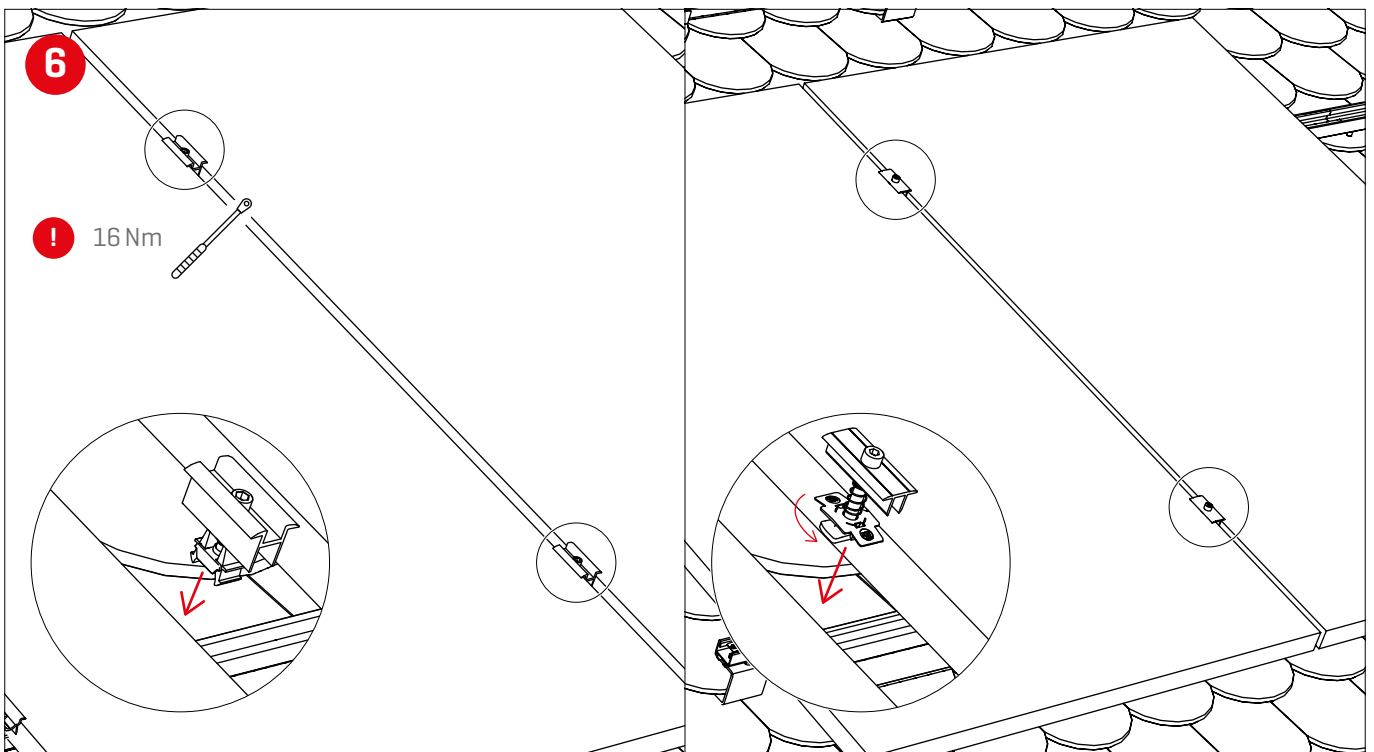
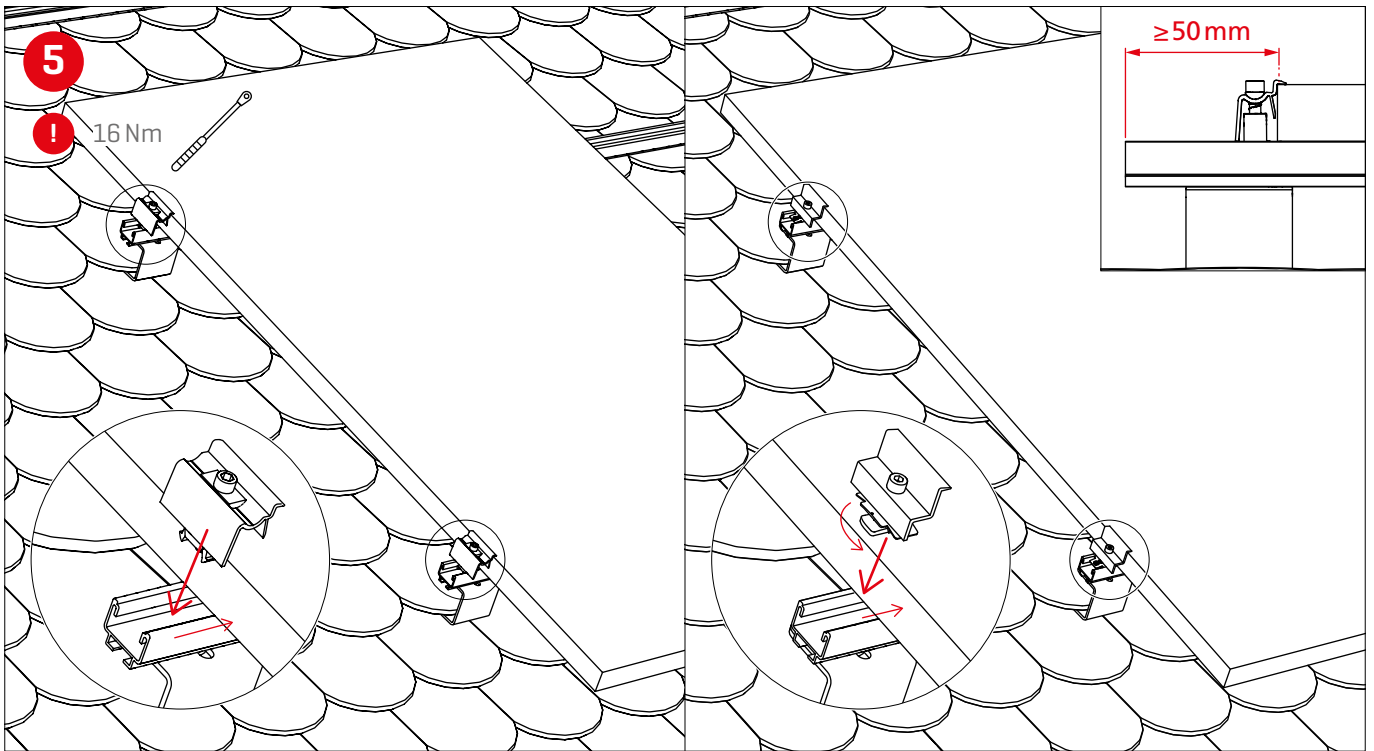

Assembly

Landscape

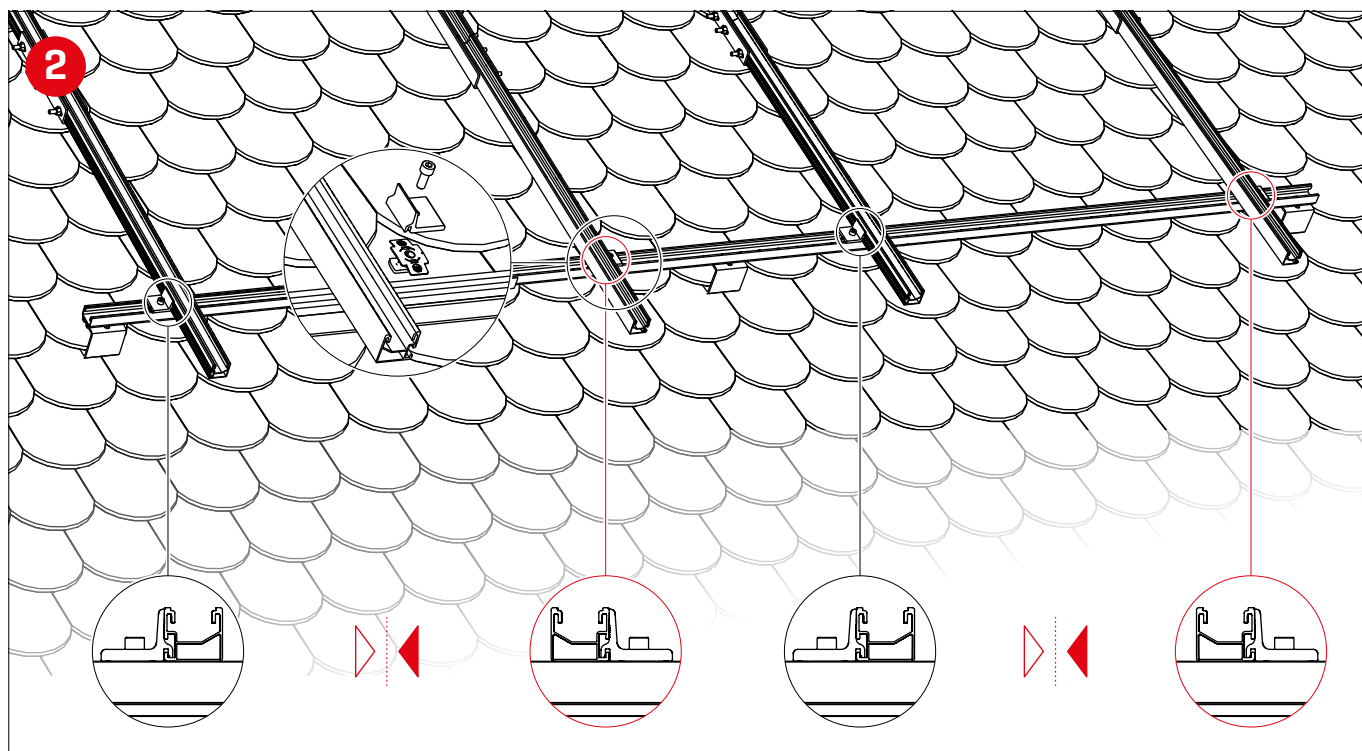
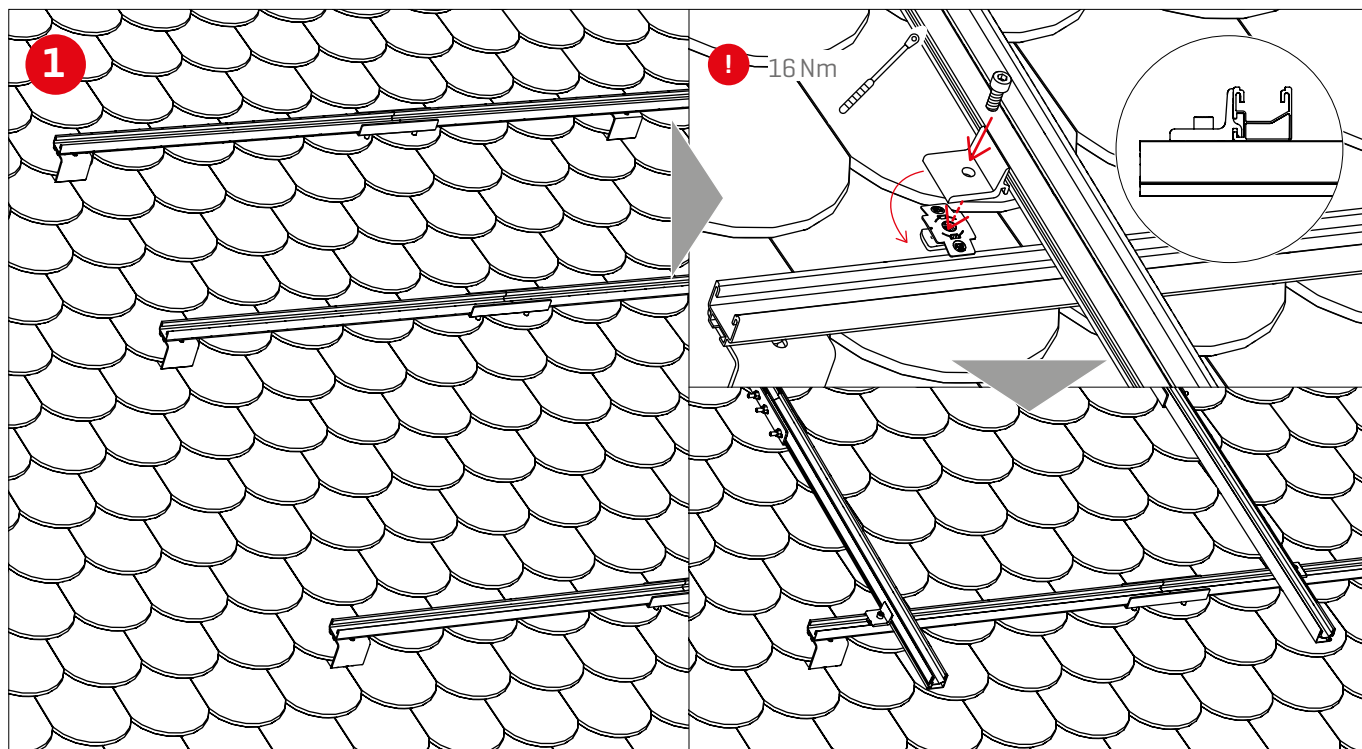

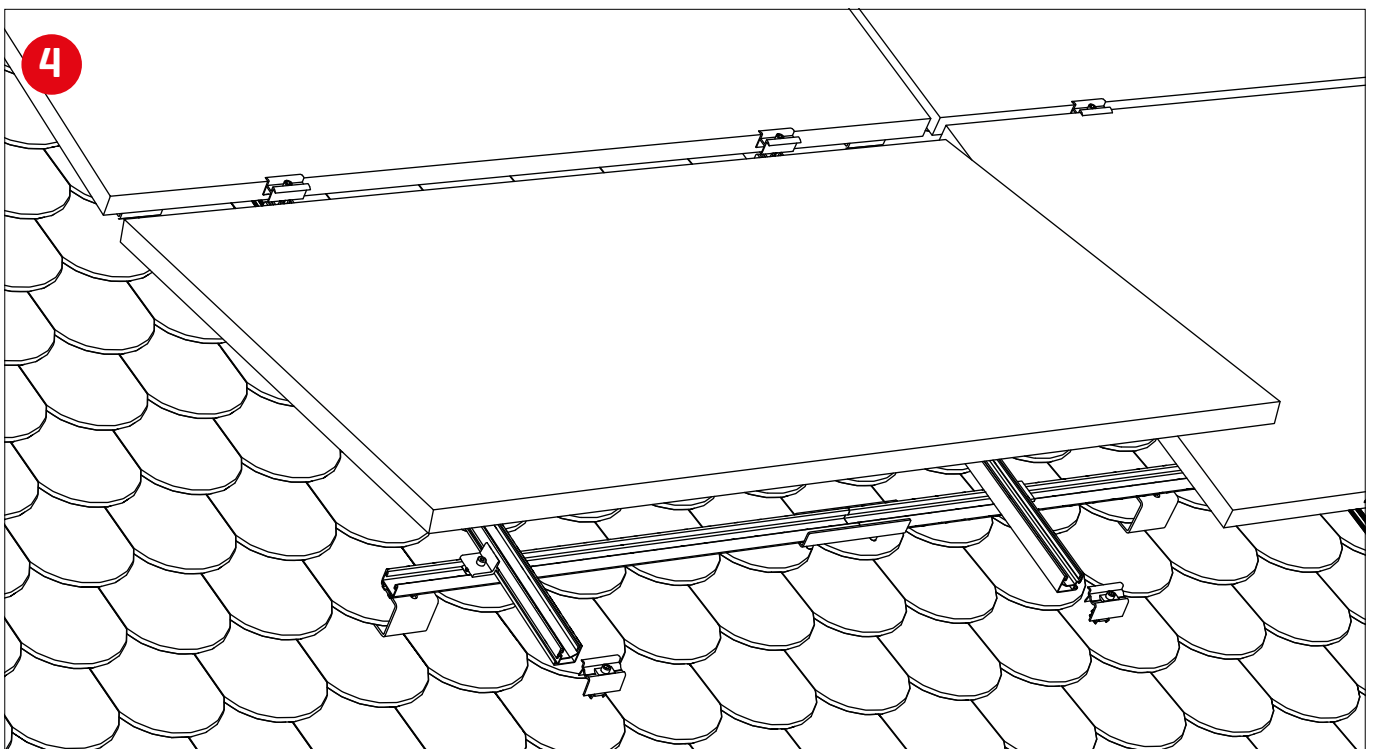
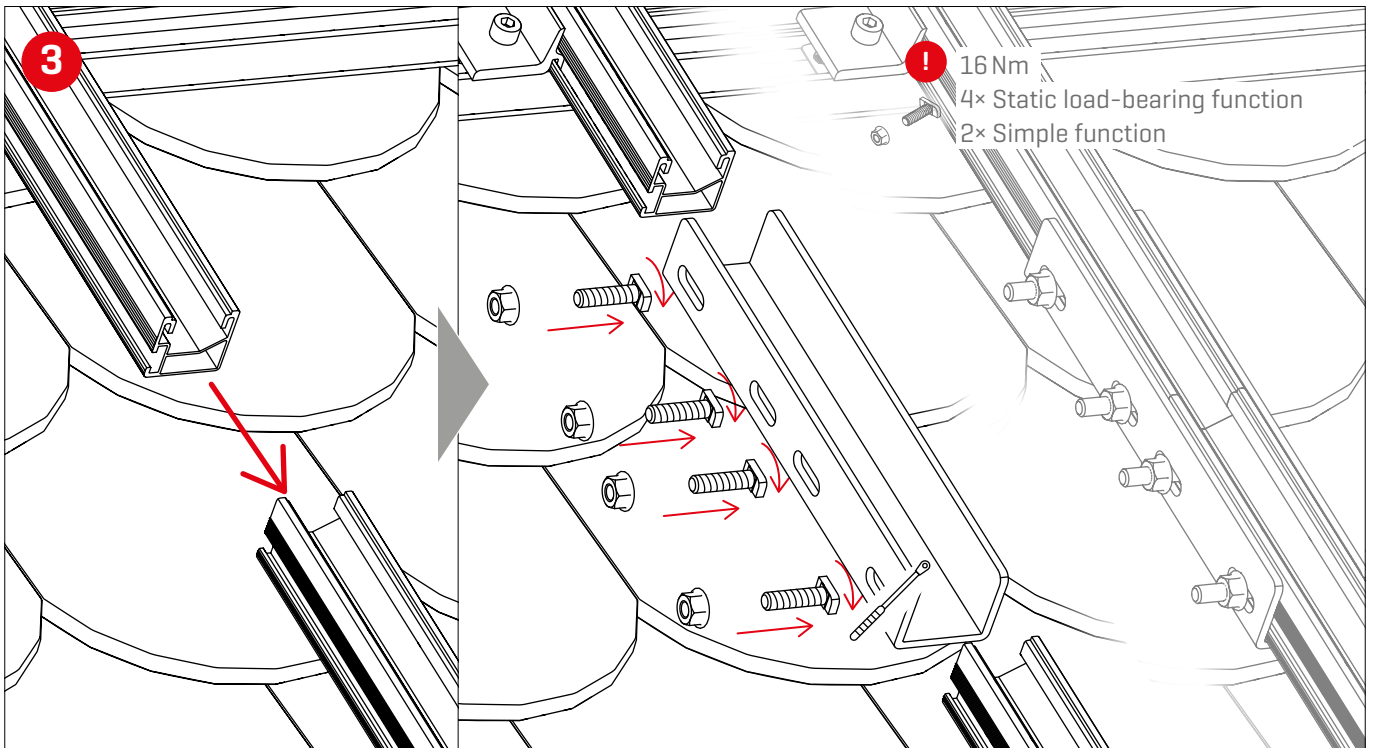

Cable Management

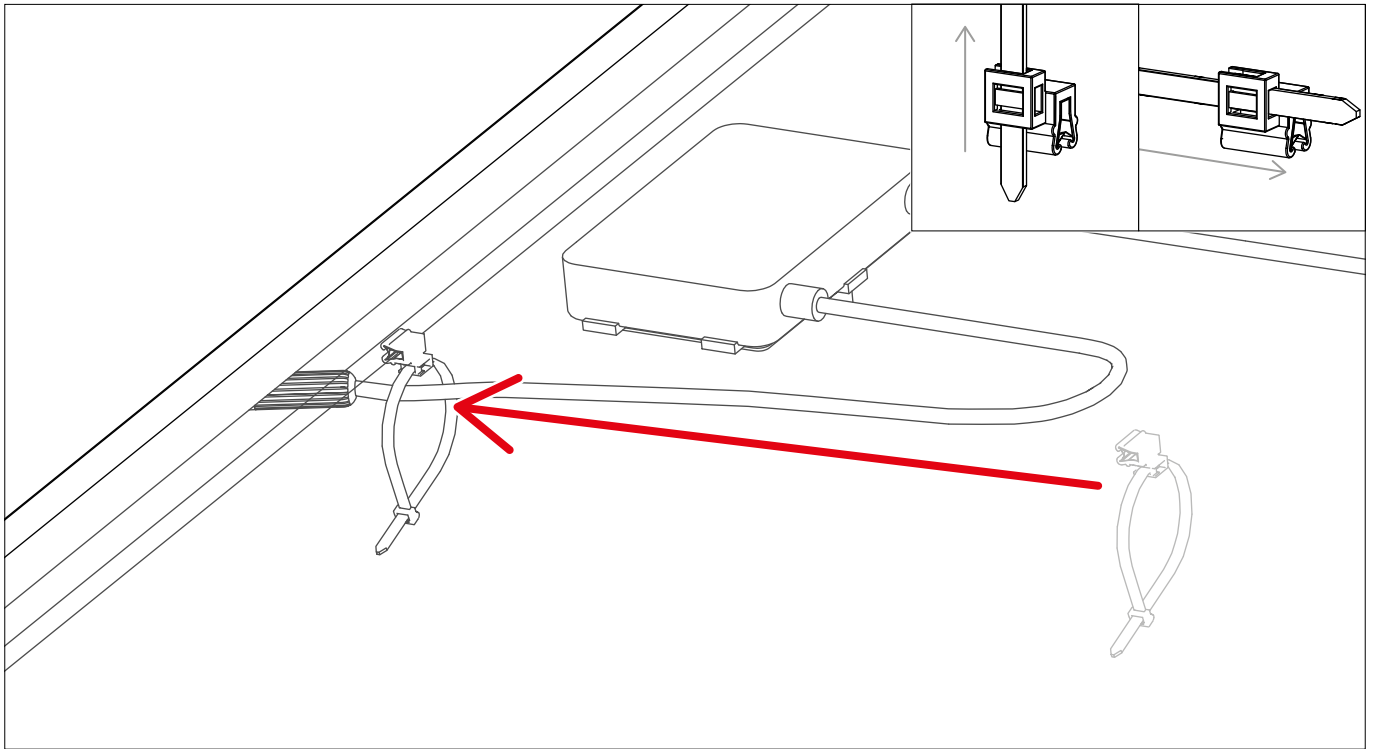

We support PV systems



Thank you for choosing a K2 mounting system.

Systems from K2 Systems are quick and easy to install. We hope these instructions have helped. Please contact us with any questions or suggestions for improvement.

Our contact data:

▶ k2-systems.com/en/contact

▶ **Service Hotline: +49 [0]7159 42059-0**

Our General Terms of Business apply. Please refer:
k2-systems.com

K2 Systems GmbH

Industriestraße 18
71272 Renningen
Germany

+49 [0] 7159 - 42059 - 0
info@k2-systems.com
www.k2-systems.com